



Designing for Libraries
Education and Community

User Guide

YAKETY YAK 200 Series

Dynamic Service Desks



If you require further information please email: enquiries@yaketyyakfurniture.com

YAKETY YAK Furniture products and trademarks are protected by international intellectual property laws.

Contents

YAKETY YAK 200 Desk Series vitals	1
Adjusting the desk height	2
Programming the height pre-sets	2
Lifting columns	3
Re-setting the column controller	3
Troubleshooting the lifting mechanism	4
Dynamic desk groupings	4
Cable management	5
CPU Box Holder option	5
Moving 200 Series desks and support modules	6-7
Stand Alone Storage Module option	8
200 Cash Module option	9
200 Book Returns Module option	10
Monitor arm option	11
D2D USB Charger option	11
POP SPOT Pencil Drawer option	11
LOLLIPOP Illuminated Sign Pole option	12
Product end of life guide	13
Warnings	14
Disclaimer	14



















YAKETY YAK Furniture is the result of 25 years' experience working alongside our customers — listening, learning and updating our products to respond to their changing needs.



If you require further information please email: enquiries@yaketyyakfurniture.com
YAKETY YAK Furniture products and trademarks are protected by international intellectual property laws.

Yakety Yak 200 Desk Series vitals

CLICK to view YAKETY YAK 200 Desk Series product pages

Product Name	Product images	Size in inches (")	Weight (lbs)	Adjustment range in inches (")	Running gear	Mobility	Cable management
200 Series Dynamic Service Desks							
201 Desk	  Left orientation Right orientation	52.16" L x 35.4" W at meeting oval	185 lbs	Seated to standing 28.74" H to 44.1" H	1500N single lifting column	Brake castors Highly mobile	6' (1800mm) cable wrap
202 Desk	  Left orientation Right orientation	63" L x 35.4" W at meeting oval	209 lbs	Seated to standing 27" H to 44.3" H	Twin 1200N lifting columns	Brake castors Highly mobile	Soft cable hooks and 6' (1800mm) cable wrap
203 Desk <small>With 2 drawer locking pedestal</small>	  Left orientation Right orientation	77.75" L x 35.4" W at meeting oval	232 lbs	Seated to standing 27.36" H to 43.7" H	Twin 1200N lifting columns	Brake castors Highly mobile	Soft cable hooks and 6' (1800mm) cable wrap
204 Desk	  Left orientation Right orientation	66" L x 33" W at meeting end	236 lbs	Seated to standing 27.36" H to 43.7" H	Twin 1200N lifting columns	Brake castors Highly mobile	Soft cable tray and 1800mm cable wrap
205 Desk Island Desk <small>With 2 drawer locking pedestal</small>	  Left orientation Right orientation	78.75" L x. 31.4" W at meeting end	287 lbs	Seated to standing 27.36" H to 43.7" H	Twin 1200N lifting columns	Brake castors Highly mobile	Soft cable tray and 1800mm cable wrap
206 Desk	  Left orientation Right orientation	59" L x 31" W at meeting end	214 lbs	Seated to standing 23.6" H to 42.9" H	Twin 1200N lifting columns	Sled Base Suit occasional re-siting	Soft cable hooks and 6' (1800mm) cable wrap
207 Island Desk	 Symmetrical	70.86" L x 31.6" W at meeting end	221 lbs	Seated to standing 23.6" H to 42.9" H	Twin 1200N lifting columns	Sled Base Suit occasional re-siting	Soft cable hooks and 6' (1800mm) cable wrap
208 Island Desk <small>With 2 drawer locking pedestal</small>	 Symmetrical	77.75" L x 35.4" W at meeting ovals	232 lbs	Seated to standing 27" H to 44.3" H	Twin 1200N lifting columns	Brake castors Highly mobile	Soft cable hooks and 6' (1800mm) cable wrap
209 Desk	  Left orientation Right orientation	82.68" L x 33" W at meeting end	285 lbs	Seated to standing 27.36" H to 43.7" H	Twin 1200N lifting columns	Brake castors Highly mobile	Soft cable tray and 6' (1800mm) cable wrap



If you require further information please email: enquiries@yaketyyakfurniture.com
 YAKETY YAK Furniture products and trademarks are protected by international intellectual property laws.

Adjusting the desk height

All our YAKETY YAK library desks feature beautifully curved, interactive desktops and are powered to adjust from seated to standing.

Your YAKETY YAK Desk comes fitted with a LINAK DPF1C height-adjust panel (Fig. 1) equipped with the following features:

- Up/down drive
- 3 memory positions
- White LED height calibration display



Fig. 1

Operation

The desk panel is operated by pressing and holding the up or down buttons to lift or lower the desk worktop. Release the button when you have reached your requested position (Fig. 2).

For detailed product information download the [LINAK User Manual](#)

Programming the height pre-sets

How to store a position

1. Drive the worktop to the desired height.
2. Press the 'S' button (Fig. 2), (an 'S' appears in the display) and then one of the three memory buttons (Fig. 3). The memory button number 1, 2 or 3 appears in the display. Your position has now been stored.
3. To clear and reset the memory button, simply choose a new height and re-save.
4. To drive the worktop to a stored position, simply press and hold the desired memory button.

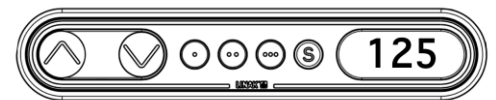

Fig. 2

Memory buttons



Fig. 3

Lifting columns

Your YAKETY YAK 200 Series Desks are fitted with either the LINAK DL2 lifting column (Fig. 4) as in the case of the 201 desk, or twin DL6 columns (Fig. 5). The columns operate in conjunction with a LINAK CBD6 controller for their height adjust functionality.

Fitted with anti-collision technology

For staff and customer safety both DL2 and DL6 height adjust systems incorporate anti-collision technology which causes the moving worktop to stop and back off should an obstruction get in the path of travel.

Re-setting the column controller

Very occasionally the controller (mounted under the desktop to the centre back) may become 'confused' and the desk will not adjust upwards. This can be caused by the worktop hitting an obstruction when in motion. In such circumstances, the DOWN button will still function.

To re-set:

1. Press the DOWN button on the desk panel until the worktop reaches its lowest level and continue to hold down for ten seconds while the controller resets itself (you may see the desktop jiggle slightly as the lifting columns re-set).

2. Now raise the worktop to the full height available and lower again to the bottom of the stroke to establish the range parameters.

Your system is now reset.

If for any reason the mechanism does not lower or reset please contact us (see contacts at the bottom of this page).

Looking after the height adjust equipment

The mechanisms will remain in good repair for many years with regular use. Not using the mechanism regularly may result in eventual damage. A good idea is to ensure the mechanisms are used sometime in every workday.

Lifting column system overuse

201 Desks (with DL2 lifting column): The height-adjust system can be used continuously for a maximum of one minute at full 150kg load, after which it should not be used for a minimum of 19 minutes.

All other 200 Series desks (with dual DL6 lifting columns): The height-adjust system can be used continuously for a maximum of two minutes at full 529lbs (240kg) load, after which it should not be used for a minimum of 18 minutes.

More prolonged use may result in overheating and a dramatic reduction in the life of the system.



Fig. 4



Fig. 5

Lifting columns (cont.)

Troubleshooting should the lifting mechanism not respond

1. Ensure the control box power lead is firmly plugged in at both ends. You will find the black control box fixed to the worktop underside, centre back. The desk panel display should be on.
2. Ensure the leads from the control box out to the lifting columns are firmly plugged in at both ends.
3. Ensure no object is in the way of worktop travel. If the desktop has impacted a stationary object it will likely require re-setting (see P3).

Dynamic desk groupings

Our 200 Series desks are designed to work alone or to group together to form dynamic front of house service points.

Complement our desks with support modules including our Book Returns Module (Fig. 6), our Cash Module (Fig. 7) or our Stand Alone Storage Module (Fig. 8).



Fig. 7



Fig. 6



Fig. 8

Cable management

All our 200 Series desks come standard with a desktop cable port (grommet) and either soft cable trays or hooks depending on the model (Fig. 9).

A 6 foot (1800mm) cable wrap is also standard to convey soft cabling to service outlets.

Additionally a Vertical CPU Box holder can be fitted if required (Fig. 9).

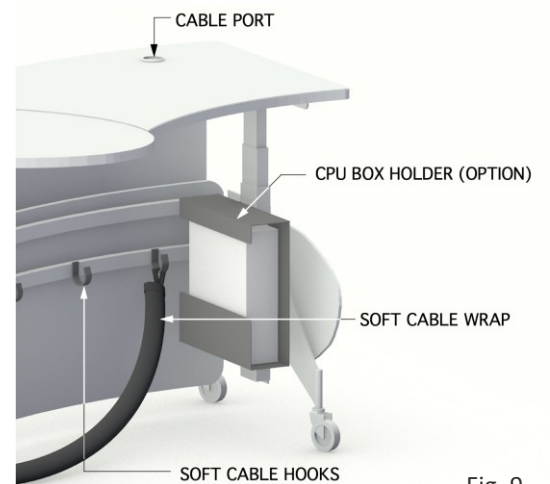

Fig. 9

CPU Box Holder option

In instances where the PC used has a separate CPU box, this can be accommodated in our vertical CPU bracket that fixes to the inside of the end frame under the desk (Fig. 10).

Our standard holder accommodates CPU boxes up to 13.75"H x 13.75"D x 3.9"W (350mmH x 350mmD x 100mmW).

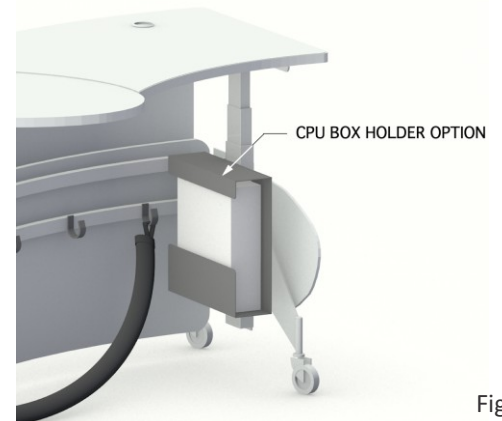

Fig. 10



Moving 200 Series desks and support modules

Most 200 Series desks come mounted on brake castors which makes moving them simple.

The 206 and 207 desks are mounted on feet. These, along with support modules, can be moved on dollies (see next page).

Moving desks fitted with castors

1. Remove or secure any articles or equipment on the worktop.
2. Raise the desk to mid height.
3. Disconnect all services and secure leads neatly out of the way on the cable hooks or in the cable tray as provided.
4. Release all four castor brakes (Fig. 11).
5. To move safely read, 'WARNING: When moving desks' on page 7.
6. With a person at each end of the desk move slowly in unison (Fig. 12).
7. Once the desk is in position lock all castor brakes (Fig. 11) and reconnect the services.

WARNING: We recommend not wheeling desks on exterior surfaces as this may damage the rubber wheels. Use dollies (Fig. 13).



Fig. 11



Fig. 12

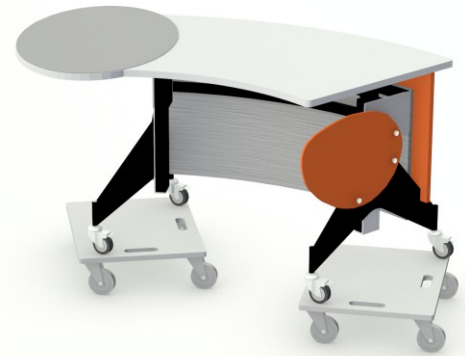

Fig. 13

Moving 200 Series desks and support modules (cont.)

Moving desks on dollies

1. Remove or secure any articles or equipment on the worktop.
2. Disconnect all services and secure leads neatly out of the way on the cable hooks or in the cable tray as provided.
3. The 206 and 207 desks are mounted on oval feet and can readily be slid short distances on carpet. A dolly under each foot will be required to move the desk any distance or across exterior surfaces (Fig. 14).
4. Lock the castors if fitted. Position a dolly beside each end of the desk then two people lift each end onto the dolly. Balance the unit evenly on the dollies.
5. To move safely read, 'WARNING: When moving desks' below.
6. With a person at each end of the desk move slowly in unison.
7. Once the desk is in position reverse the process to remove the dollies.
8. Reconnect the services.
9. For Book Returns Modules a dolly under each end will be required.
10. For Cash Modules one dolly positioned centrally is sufficient (Fig. 15).



Fig. 14



Fig. 15

WARNING: When moving desks, with or without dollies

1. First check to ensure your route is clear.
2. Be particularly careful on ramps. Use a third person at the front to help slow and guide the descent.
3. Once in the new location ensure all castor brakes are locked (if fitted).

Stand Alone Storage Module option

[CLICK to view Stand Alone Storage Module](#)

Our desks are designed with the emphasis on ease of interaction with your public, so on the smaller desks there is little room for storage.

Our 203, 205 and 208 desks do come standard with a small two drawer locking pedestal. All desks can be fitted with our [POP SPOT Pencil Drawer](#).

Where you have significant storage requirements, we offer our Stand Alone Storage Module (Fig. 16) as a freestanding solution providing four locking drawers and additional worktop space for secondary items like pamphlet display.

The Stand Alone Storage Module positions beside the desk at the non-meeting end (Fig. 17, Fig. 18).



Fig. 16



Fig. 17



Fig. 18

200 Cash Module option

[CLICK to view 200 Cash Module](#)

The 200 Cash Module (Fig. 19) provides a secure place for cash registers and credit terminals. It pairs seamlessly with our 200 Series desks positioning beside or between for direct access.

The Cash Module features a toughened glass security cowling around a well which securely houses equipment at an ergonomic height. Below, a drawer and two shelves provide general storage (Fig. 19, Fig. 20).

The Cash Module is often positioned beside or between counters. Floor services can be located under the Cash Module which provides a hatch to access the kicker space and a cable port each side of the cabinet to facilitate cable reticulation (Fig. 21).

Often floor services are located under the Cash Module to allow soft cabling to reticulate out from there. To facilitate cable reticulation a cable port is fitted to the kicker plate on both sides of the cabinet.

In the kicker space we provide fixing brackets as the module should be fixed to the floor (Fig. 21).

WARNING: For stability and safety, the Cash Module should be fixed to the floor using the brackets and fixings provided.



Fig. 19



Fig. 20

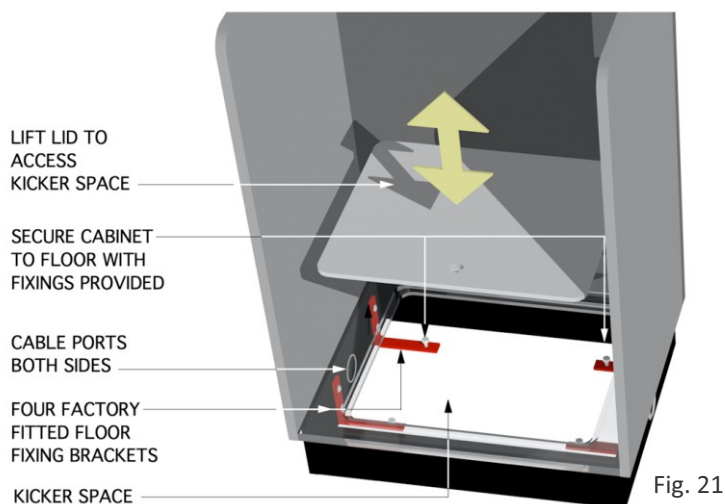

Fig. 21

200 Book Returns Module option

[CLICK to view 200 Book Returns Module](#)

The 200 Book Returns Module (Fig. 22) provides a tidy surround for your returns bin for a seamless circulation area aesthetic. A shelf and slide deliver books tidily to the bin. The module is designed to pair with 200 Series desks or can stand alone.

We can cut back the side panel facing the desk to allow more direct access by staff to the book bin (Fig. 23).

The Book Returns Module is fitted with four brackets as the module should be fixed to the floor (Fig. 24).

WARNING: For stability and safety, the Book Returns Module should be fixed to the floor using the brackets and fixings provided.



Fig. 22



Fig. 23

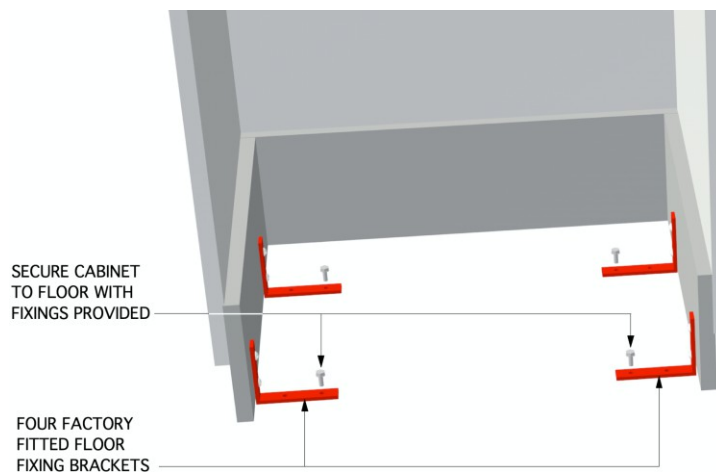

Fig. 24

Monitor arm option

[CLICK to view ATDEC Monitor Arms](#)

For desks utilising one of our ATDEC Monitor Arm options (Fig. 25), the arms ship boxed and require assembly and mounting by the customer.

A factory drilled mounting hole is provided on the desktop in the optimum position to suit the particular monitor arm.

Each arm comes with full installation instructions in the box.



Fig. 25

D2D USB Charger option

We recommend your desk be fitted with a handy D2D USB Charger, which provides one USB-A and two USB-C high speed sockets right at your finger tips (Fig. 26).

Our D2D USB Charger come factory fitted and ready to use. The D2D does not require its own power supply as it conveniently plugs into the LINAK desk height control box.



Fig. 26

Pop Spot Pencil Drawer option

[CLICK to view POP SPOT Pencil Drawer](#)

For your bits and pieces, our POP SPOT Pencil Drawer (Fig. 27) provides a handy tidy-all for pencils, pens, post-its etc. The drawer comes factory fitted.



Fig. 27



If you require further information please email: enquiries@yaketyyakfurniture.com
YAKETY YAK Furniture products and trademarks are protected by international intellectual property laws.

Lollipop Illuminated Sign Pole option

[CLICK to view LOLLIPOP Illuminated Sign Pole](#)

The Lollipop Illuminated Sign Pole (Fig. 28) is a great way to catch attention and to guide enquirers to your desk for assistance. The unit is pre-wired to the desk and ships flat to minimise shipping charges. The sign pole requires simple mounting by the customer.

WARNING Lollipop is delicate - fabricated in acrylic and fitted with a low voltage LED lighting system, it needs to be handled carefully.

To commission

Lollipop comes fully assembled and pre-wired. Sufficient play in the cabling is allowed so the pole can be layed flat on the desktop for shipping. From the pole the cable reticulates down the mounting hole in the desktop.

1. After unwrapping, raise the pole to a vertical position over the hole and feed the surplus cable back up into the pole. The round sign head should be aligned to the desktop centreline. (Fig. 29).

2. In the bottom of the pole you will see two grooves, one either side (Fig. 30). Also, under the desktop you will see a white mounting bracket in line with the mounting hole in the desktop. The grooves in the pole are designed to locate over two corresponding lugs in the mounting bracket. Carefully, lower the pole into the mounting hole until it is firmly located (Fig. 30, Fig 31).

The Lollipop Illuminated Sign Pole is now ready to use. The light can be turned on and off using the black button on the desktop (Fig. 28).

To apply graphics to the sign pole head

If you have not ordered the sign pole display panels to have graphics applied at the factory, you can arrange with your own signage contractor to do this on-site. We advise the pole be lifted clear of the mounting hole and laid flat on a soft cloth on the desktop in order to apply the graphics.

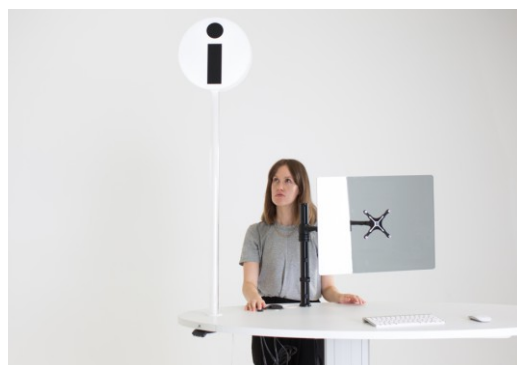

Fig. 28

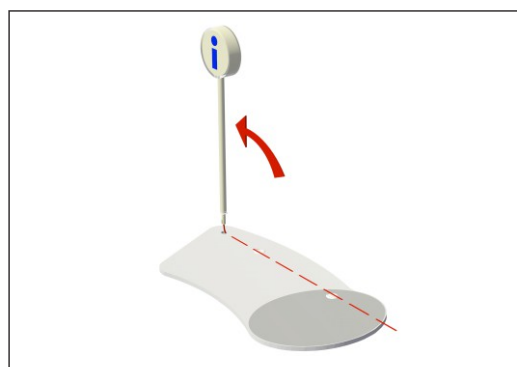

Fig. 29

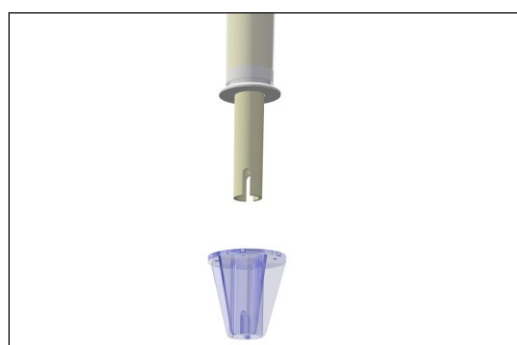

Fig. 30

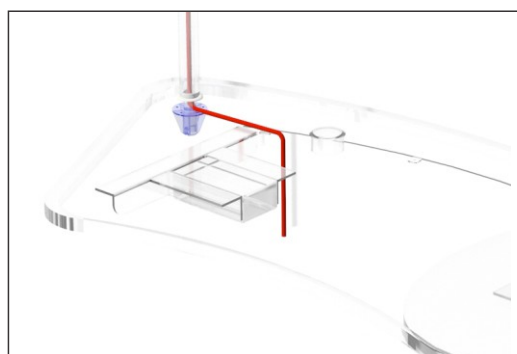
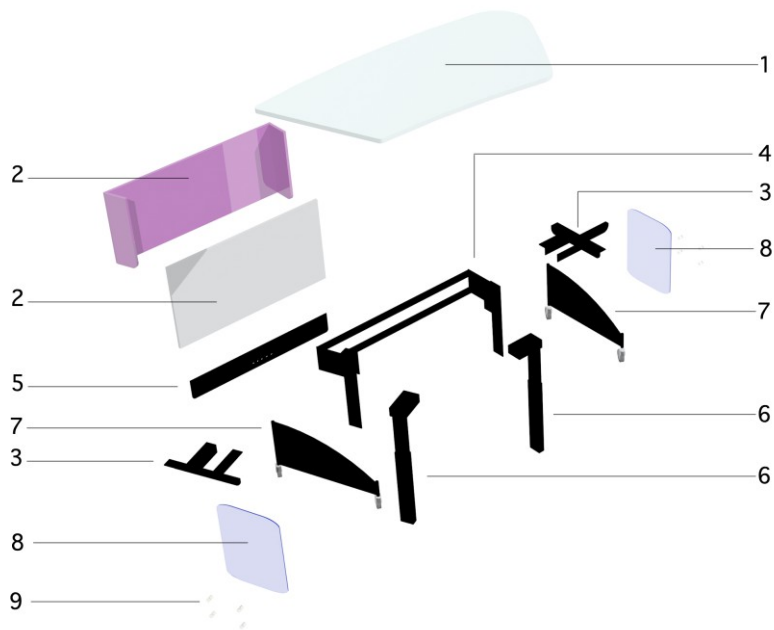

Fig. 31

Product end of life guide

Our desks are designed smart and strong and are intended to serve you for many years. When the time does come to retire your desk you can do so responsibly as we design them to readily disassemble.

Here is a guide for recycling or disposing of component parts



COMPONENT INDEX

Component	Material	End of life action
1 Worktop/Bag shelf	HPL laminate on E0 MDF	Upcycle or landfill
2 Upper/Lower panelwork	LPL laminate on E0 MDF	Upcycle or landfill
3 Top plate	Mild steel	Metal recyclers
4 Cross brace	Mild steel	Metal recyclers
5 Cable tray	Mild steel	Metal recyclers
6 Adjustable leg	Mild steel	Metal recyclers
7 Castor plate	Mild steel	Metal recyclers
8 Side screen	Acrylic	Upcycle or landfill
9 Screen mounts	Stainless steel	Metal recyclers

NOTE: electronic height adjust components including control box and leads are not shown but these can be taken to your **electronics recyclers**

Warnings

YAKETY YAK 200 Series Desks contain moving and electrical parts and as such are potentially hazardous if handled or operated incorrectly.

Operating the height adjustment mechanism

1. Always check that there are no obstructions under, on top or alongside the desk that could impact the direction of travel of the worktop.
2. Ensure there is sufficient slack in any leads to equipment on the worktop, to allow for the full range of movement of the worktop.
3. Do not store anything under the desk that encroaches into the operating height range of the mechanism.
4. Always keep clear of moving parts when operating the mechanism.
5. Be aware of other people nearby when operating the mechanism. Particularly watch for children.

Moving the desk

6. Always disconnect all services to the desk and lift the leads clear before moving the desk.
7. Then, check to ensure your route is clear. Be particularly careful on ramps.
8. To move, position a person at each end. Use a third person at the front to help slow and guide the descent on ramps.
9. Once in the new location ensure all castor brakes are applied (if fitted).

Floor fixing

10. To ensure stability and safety, cash and book return modules should be fixed to the floor during installation using the brackets and fixings provided.

Disclaimer

We provide this Yakety Yak 200 Series User Guide in good faith to assist you in understanding and using our products. In doing so Yakety Yak Furniture assumes no responsibility or liability for your use of the information provided and gives no guarantees of its completeness, accuracy, usefulness, timeliness or avoidance of expense, damage, injury, or harm. Yakety Yak Furniture also retains the right to alter its products at any time without warning.



If you require further information please email: enquiries@yaketyyakfurniture.com
YAKETY YAK Furniture products and trademarks are protected by international intellectual property laws.