



Designing for Libraries
Education and Community

Delivery and Installation Guide



100 Series Pods



200 Series Desks



300 Series Counters



400 Series
Economy Desks



If you require further information please email: enquiries@yaketyyakfurniture.com

YAKETY YAK Furniture products and trademarks are protected by international intellectual property laws.

Contents

Delivery address and contact person	1
Site access considerations	1
How YAKETY YAK Desks are crated	2
Your order in transit	3
Preparing for delivery	3
Checking crates for damage	4
Checking product for damage	4
De-crating	5-6
Positioning desks to best suit your site	7
Installation	8-9
Cable management	10-11
CPU Box Holder option	12
Adjusting the desk height	12-14
Programming the height pre-sets	14
Lifting columns	15-16
Re-setting the column controller	15
Troubleshooting the lifting mechanism	16
Monitor arm option	16
D2D USB Charger option	16
LOLLIPOP Illuminated Sign Pole option	17
Warnings	18
Disclaimer	18



YAKETY YAK Furniture is the result of 25 years' experience working alongside our customers — listening, learning and updating our products to respond to their changing needs.



If you require further information please email: enquiries@yaketyyakfurniture.com
YAKETY YAK Furniture products and trademarks are protected by international intellectual property laws.

Delivery address and contact person

At the quotation stage, we will request confirmation of your delivery address as well as your contact person with whom our shippers may liaise for delivery. It is very important that details are accurate. Also, if there is any specific information we need to know regarding site access, please inform us at this time.

For example:

1. Where should the delivery truck park in relation to the building?
2. Do you have a delivery dock?

Site access considerations

We advise you to plan well in advance of delivery how the furniture will be brought into the building and conveyed to the installation area. We are happy to provide guidance.

Some things to consider are:

1. What team should be available on delivery day?
2. How best to bring the items into the building? Do you have a loading dock or ramp?
3. Will furniture fit through doorways and security gates? We can confirm the size of each item. Some customers opt to bring the unopened crates into the building, and again we can confirm their exact size.
4. If using a lift, will the items fit? We can provide a lift plan on which you can confirm key measurements (Fig. 1). From this, we can check to ensure desks will fit (Fig. 2).

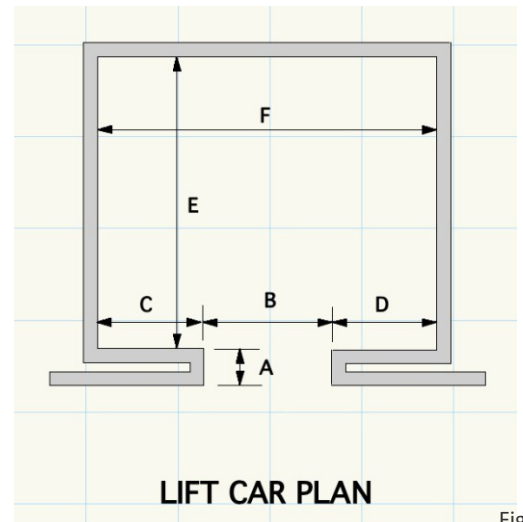

Fig. 1

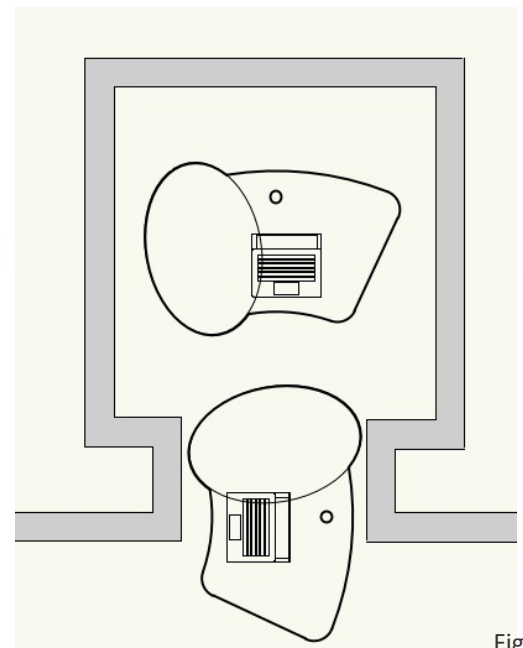

Fig. 2



How Yakety Yak Desks are crated

YAKETY YAK counters, desks, pods, cash and book returns support modules are all shipped fully assembled in individual crates (Fig. 3, Fig. 4).

Smaller items, including Stand Alone Storage Modules, Under Counter Storage Modules and monitor arms are secured separately in the crate (Fig. 5).

Lollipop Illuminated Sign Poles ship pre-wired and laid flat on the desktop, requiring simple mounting by the customer (Fig. 6). For the Lollipop mounting guide refer to page 17.



Fig. 3



Fig. 4



Fig. 5



Fig. 6



If you require further information please email: enquiries@yaketyyakfurniture.com
YAKETY YAK Furniture products and trademarks are protected by international intellectual property laws.

Your order in transit

Once your order leaves our factory, our project management team monitors progress with our shippers. Closer to delivery, you will be contacted to be advised of the likely delivery date. We will also remind you of your responsibilities regarding receiving the goods and checking for damage.

Preparing for delivery

Once we advise you of the likely delivery time, you need to ensure that your site team is prepared to receive the goods. Shippers (being what they are) are seldom able to give an exact day or time for delivery, however our team will be working with them to give you the most updated information available. We will also instruct our shippers to notify your delivery contact when they are close to delivery.

ATTENTION: You are about to receive one or more large, heavy MDF crates. An average desk will ship in a crate measuring around 2.0m x 1.0m x 0.8mH, weighing around 220kg. We encourage you to take the time to prepare a considered plan around the delivery and installation of your new furniture. Following are some helpful points.

Preparation checklist:

1. Be ready to direct the truck to the optimum drop spot for the crates, in relation to accessing your building with the desks later. The truck will have a tail lift, and the driver will unload the crates and place them near the truck where you direct. (NOTE: It is not the drivers job to take the crates further, you have paid for kerbside delivery.)
2. Be ready to move the crates to an area where they may be opened and the desks removed. This area should be handy to the building entrance. Using a handtruck (Fig. 7), the crates are straightforward to move over level, hard surfaces.
3. If you cannot place the crates out of the weather, be prepared for rain. The crates are not waterproof and tarpaulins may be required to protect them until they can be opened.
4. If your site allows, it is easiest to take the crates into the building, or a covered area to unload.



Fig. 7

Checking crates for damage

As the crates are unloaded, a designated person should check each crate for obvious signs of damage.

Crate damage

Should crate damage be discovered, take several pictures of the damage and note the damage clearly on the delivery docket BEFORE signing and returning the driver's copy. Do not allow yourself to be rushed by the driver, you have a right to carefully assess the condition of the crates. Typical damage may include fractured or punctured panels.

The picture on the right (Fig. 8) shows where a forklift prong has punctured through a crate side panel likely damaging the desk inside. If crate damage is found YAKETY YAK Furniture should be notified immediately and pictures provided, along with a copy of the signed delivery docket which notes the damage.



Fig. 8

Checking product for damage

Be organised to open the crates and remove the contents as soon as possible, particularly if crate damage has been found. Each item should be carefully checked for damage and if discovered, several photographs should be taken.

YAKETY YAK Furniture should be notified within three (3) working days of delivery with a clear description of the issues, supported by photographs. This allows YAKETY YAK Furniture sufficient time to make a claim against the consignment's insurer. Fig. 9 shows one of our pods with a snapped worktop caused by the crate having been dropped during handling in transit. Damage is usually less dramatic like the clashing damage to the worktop (Fig. 10), likely caused by a custom officer's crowbar during an inspection.

Instances of damage are rare, but we understand the inconvenience to our customers this may cause. Once notified our team will work hard to rectify the damage in the earliest possible time.

NOTE: In cases where the delivery procedures outlined above and in our Conditions of Sale are not kept by the customer then YAKETY YAK Furniture shall not be held liable for the repair or replacement of damaged goods.



Fig. 9



Fig. 10



If you require further information please email: enquiries@yaketyyakfurniture.com
YAKETY YAK Furniture products and trademarks are protected by international intellectual property laws.

De-crating

Dismantling the crate

Use a drill with square drive to unscrew each crate panel; top panel first then front and back panels. This leaves the two end panels; unscrew along the bottom edge and remove. This leaves just the crate base making it easier to access and remove the contents (Fig. 11).

Preparing the contents for removal

Remove any smaller items like monitor arm boxes or storage pedestals first. We use various methods to secure desks and support modules in the crate.

1. Our pods are secured using crate clamps fixing down the pod base. Each clamp is fastened with four pozi screws into the crate base panel. (Fig. 12). Remove all clamps before moving the pod.

2. Our castor mounted desks have chocks for each castor to nest in. Additionally, a strap is fixed across the top of the castor and screwed each end to the crate base. To remove the desk, cut or unscrew all the ties and lift each castor clear of the chocks (Fig. 13).

3. Our counters, cash and book return modules have MDF panels fixed to their bases to protect them when moving (Fig.14). To remove the counter or support module from the crate, first unscrew the protective panel from the crate base, leaving the panel still fixed to the counter.

4. Our 206 and 207 Desks have flat oval feet which are fixed to the crate base with three pozi screws through each foot (Fig.15). To release the desk, unscrew all screws from both feet.

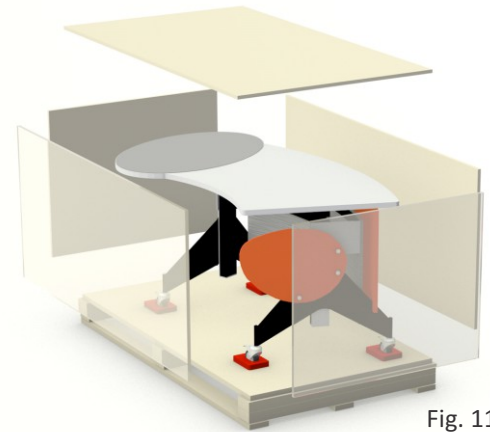

Fig. 11

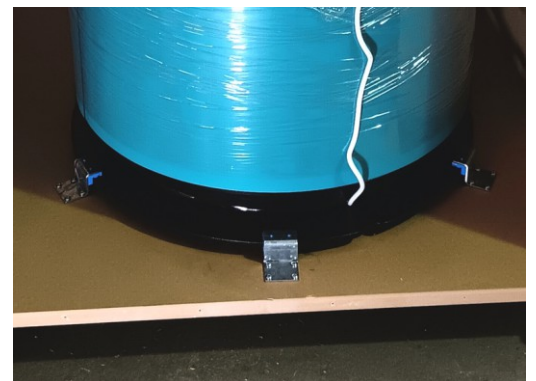

Fig. 12

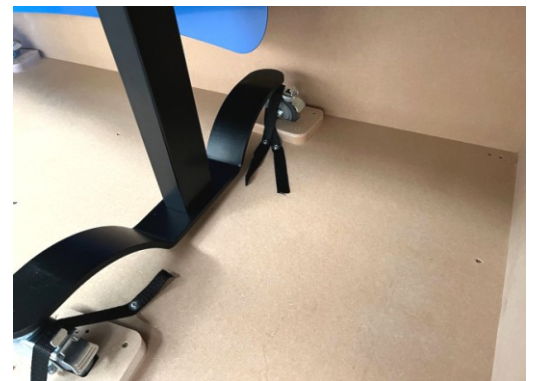

Fig. 13



Fig. 14



Fig. 15

De-crating (Cont.)

Removing desks with castors from the crate

If you are unloading the crates on an internal surface, you can use a crate side panel as a ramp (secure with a screw into the crate base at each end). Release the castor brakes and with a person at each end, guide the desk down the ramp (Fig. 16).

WARNING: If you are unloading the crate on an exterior surface, wheeling the desk can damage the castor wheels.

If unloading onto an exterior surface, the desk can be wheeled sideways onto two dollies (Fig. 17). Once the desk is balanced on the dollies, lock all four castor brakes. The desk can now be carefully moved inside with a person at each end.

WARNING: Extra care is required taking desks up ramps; you may need two people at the lower end.

Removing desks and modules with no castors from the crate

Release the desk from the crate base, and slide sideways onto the dollies. Our pods and cash modules require just one dolly. (Fig. 18, Fig. 19).

Our counters, book returns modules, 206, and 207 desks require two dollies. (Fig. 20, Fig. 21). Remember to leave the protective panel on counters, cash and book returns modules for moving on dollies.

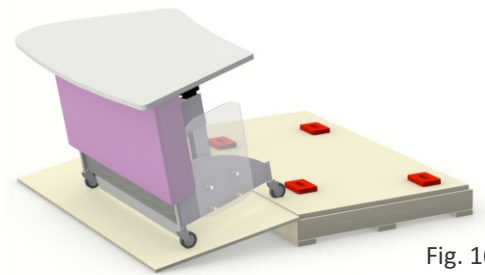

Fig. 16



Fig. 17



Fig. 18



Fig. 19

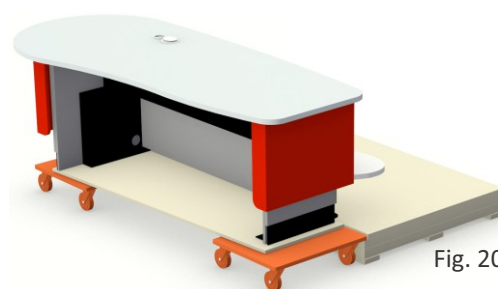

Fig. 20



Fig. 21

Positioning desks to best suit your site

How your new desks will be positioned in your space requires careful consideration. At the planning stage, should you require assistance, our design team is always ready to help and can prepare space plans (Fig. 22) demonstrating how our desk(s) may best fit your site.

Some points to consider in positioning your desk(s):

1. Is the desk visible to in-coming customers?
2. Do staff at the desk have a clear view of the surrounding library space?
3. Will the selected location disrupt or enhance the flow of people through the space?
4. Does the location support 'quiet' interaction with customers (Fig. 23)?
5. Does the desk have ready access to service outlets (power/data etc;)?
6. Is there sufficient circulation space around the desk for staff with book trolleys?
7. Is there suitable access to workrooms and support services (copiers, printers, storage etc;)?

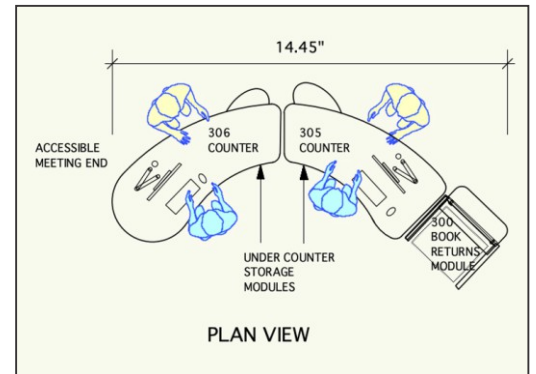

Fig. 22



Fig. 23

Installation

100 Series Pods

Our pods, along with their cash and work support modules, simply 'park' in the position and at the angle you require (Fig. 24).

WARNING: If your pod is fitted with retracting castors (once the pod is in position) ensure the castors are fully raised, so that the pod baseplate rests firmly on the floor.

200 Series Desks

Our desks simply 'park' in the position and angle you require. If your desk is fitted with brake castors, ensure all four brakes are applied once the desk is in position (Fig. 25).

Cash Modules and Book Returns Modules are fitted with brackets, and should be fixed to the floor (Fig.26, Fig. 27).

WARNING: For stability and safety, Cash Modules and Book Returns Modules should be fixed to the floor using the brackets and fixings provided.



Fig. 24



Fig. 25

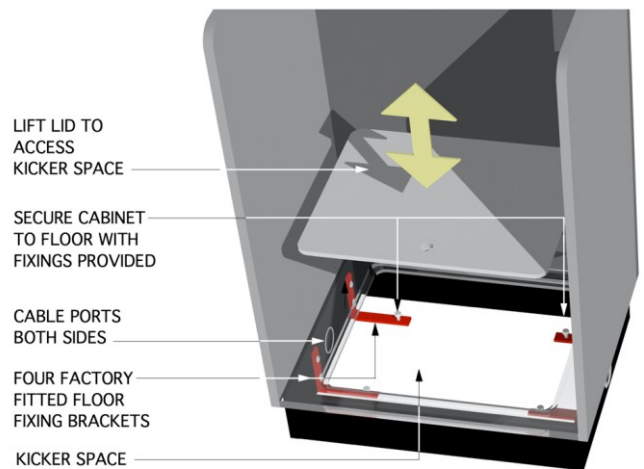

Fig. 26

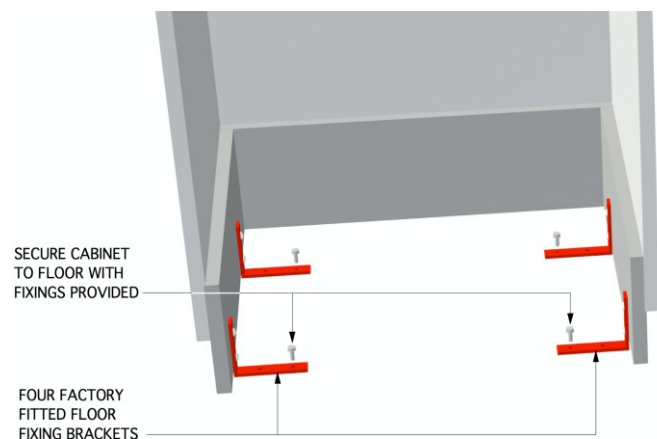

Fig. 27



If you require further information please email: enquiries@yaketyyakfurniture.com

YAKETY YAK Furniture products and trademarks are protected by international intellectual property laws.

Installation (Cont.)

300 Series Counters

Our counters can stand alone (Fig. 28) or group together with support modules (Fig. 29). If grouped, an infill panel links the counters and modules together. The infills set the correct distance between modules, and facilitate cable reticulation (see Cable Management section below).

NOTE: An installation plan is supplied with all jobs involving counter groupings (Fig. 30).

Cash Modules and Book Returns Modules are fitted with brackets, and should be fixed to the floor (Fig.26, Fig. 27 previous page).

WARNING: For stability and safety, counters, cash and book returns modules should be fixed to the floor using the brackets and fixings provided and as detailed in the installation plan provided.

400 Series Desks

Our desks simply 'park' in the position, and angle you require (Fig. 31). Ensure all four brakes are applied, once the desk is in position (Fig. 25 previous page).

Cash Modules and Book Returns Modules are fitted with brackets, and should be fixed to the floor (Fig.26, Fig. 27 previous page).

WARNING: For stability and safety, both the Cash Module and Book Returns Module should be fixed to the floor using the brackets and fixings provided.



Fig. 28

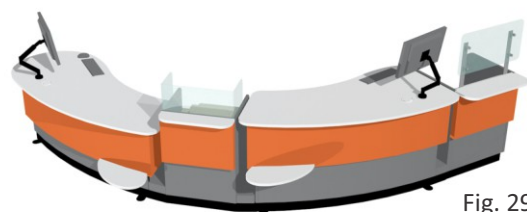

Fig. 29

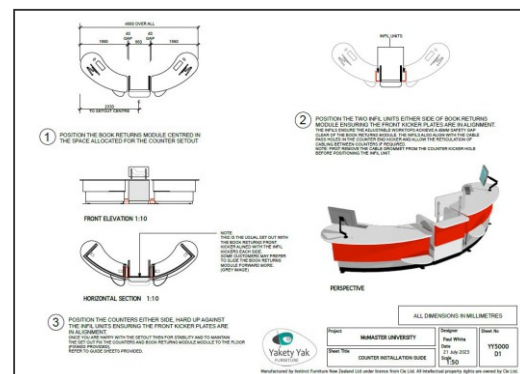

Fig. 30



Fig. 31



If you require further information please email: enquiries@yaketyyakfurniture.com
YAKETY YAK Furniture products and trademarks are protected by international intellectual property laws.

Cable management

All our pods, desks and counters come standard with at least one desktop cable port (grommet) to convey soft cabling to outlets (Fig. 32).

100 Series Pods

Fig. 33

Counter soft cable reticulation

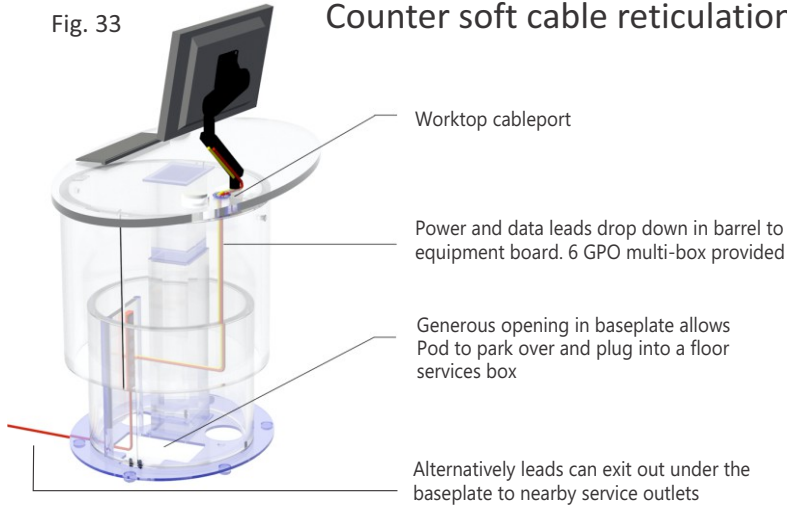

Pods are designed to accommodate soft cabling neatly inside the barrel (Fig 33). All leads from desktop equipment must deliver into the barrel space below, via the cable port (grommet) provided.

Ideally, the pod can be situated over a floor services box and the multi-box plugged in via the access hole in the baseplate (Fig. 34). If there is no service box over which the desk can park, then soft cabling can be taken out under the baseplate to plug into adjacent services on walls, columns or service poles (Fig 33). Equipment can be plugged into the six outlet multi-box mounted on the equipment panel (Fig. 35).

NOTE: YAKETY YAK requires one of the outlets for its own height-adjust equipment leaving five outlets for your use.

WARNING: Between the upper barrel and the desktop underside is a narrow ventilation gap. **DO NOT** reticulate leads from the desktop into the barrel space via this gap. The leads will prevent the upper barrel from locating and locking onto its hanging brackets, allowing the barrel to drop off.



Fig. 32

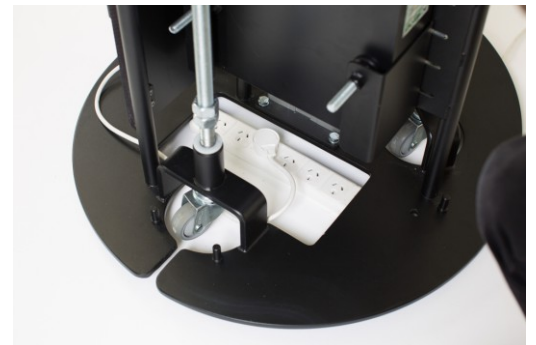

Fig. 34



Fig. 35

Cable management (Cont.)

200 Series and 400 Series Desks

Our desks are either fitted with soft cable trays or cable hooks, depending on the model (Fig. 36).

Additionally, 200 Series desks come with a 1800mm cable wrap to convey soft cabling to service outlets (Fig. 36, Fig. 37).

300 Series Counters

Our counters are designed to allow soft cabling to reticulate from module to module (Fig. 38). Each counter has a cable port fitted in the worktop, and, under the counter, a cable tray allows soft cabling to be collected and directed. At each end of the counter, a cable port in the kicker allows soft cabling to exit to outlets or to the next module.

The 300 CASH Module is often positioned beside or between counters. The design provides a hatch to access the kicker space. Often floor services are located under the Cash Module to allow soft cabling to reticulate out from there. Like the counters, a cable port is also provided in the kicker on both sides of the cabinet.

To tie counters and support modules together as one installation, as well as to facilitate cable reticulation, our counters employ Infill Modules. Infills incorporate a lid to allow easy access to cabling, and openings in their sides align with the end cable ports of adjacent modules. This allows soft cabling to reticulate tidily through the installation.

NOTE: An installation plan is supplied with all jobs involving counter groupings.

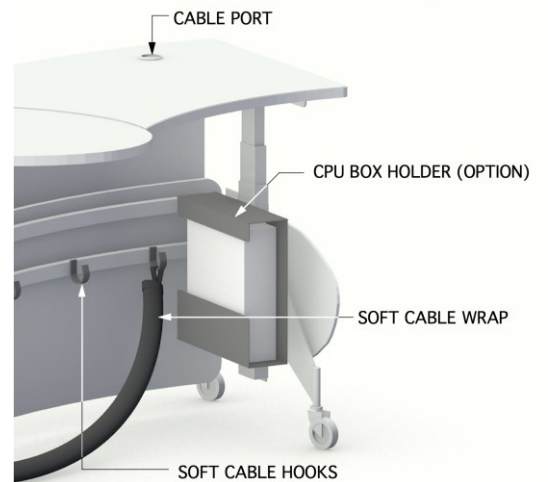

Fig. 36



Fig. 37

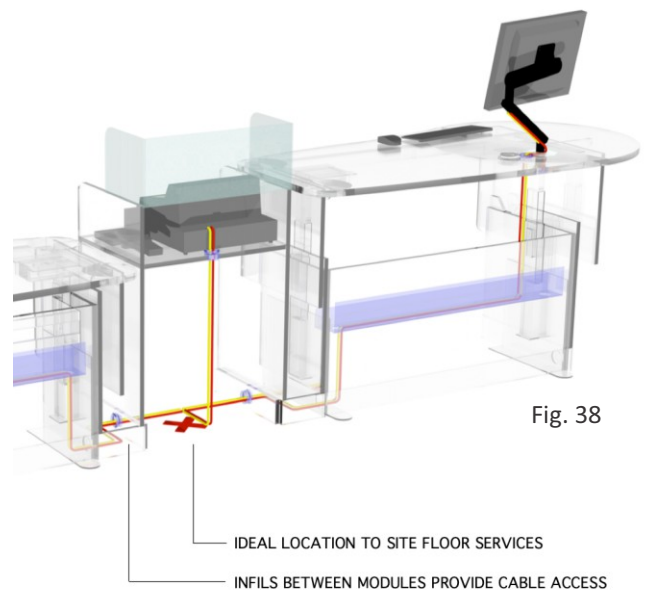

Fig. 38

CPU Box Holder option

CPU Box Holder option for pods

The vertical CPU holder mounts inside the barrel (Fig. 39) and adjusts to accommodate CPU boxes up to 380mmH x 325mmD x 100mmW.

CPU Box Holder option for desks and counters

Desks and counters can be fitted with our vertical CPU bracket to accommodate a CPU box. The bracket fixes to the inside of the end frame, under the desk (Fig. 40). Our standard holder accommodates CPU boxes up to 350mmH x 350mmD x 100mmW.



Fig. 39

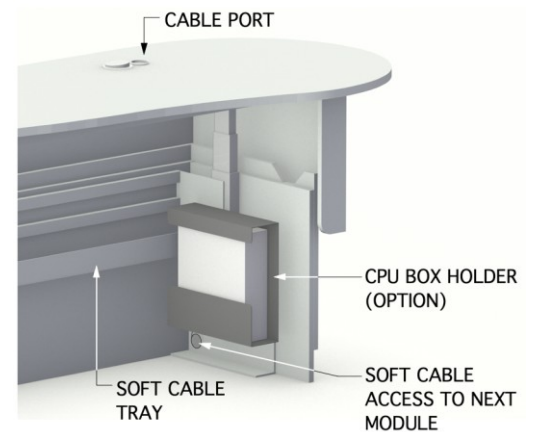

Fig. 40

Adjusting the desk height

All our YAKETY YAK pods, desks and counters are fitted with world class LINAK technology to enable the worktops to adjust effortlessly from seated to standing heights.

Pods and 400 Series Desk height adjustment

YAKETY YAK Pods and 400 Series Desks come fitted with a LINAK DPI1C height-adjust panel (Fig. 41, Fig. 42) equipped with the following features:

- Up/down drive
- 3 memory positions
- White LED height calibration display



Fig. 41



Fig. 42

Adjusting the desk height (Cont.)

Operation

The desk panel is operated by pressing and holding the up or down buttons to lift or lower the desk worktop. Release the button when you have reached your requested position (Fig. 43).

For detailed product information download the [LINAK User Manual](#)

If favourite positions have been saved and automatic drive is enabled: simply double-tap up or down to drive the desk to a favourite position (Fig. 44).

Download the height adjust functions App

Pre-set heights and other functions are controlled via the App. The app is connected to the desk via Bluetooth® Low Energy technology integrated in the DPI1C.

How to download the app for iOS

- Step 1: Use your iPhone to login to AppleAppStore
- Step 2: Type 'Desk Connect' in the search column
- Step 3: Select the 'Desk Connect' app
- Step 4: Click 'install' to download the app to your device

You can also scan this QR code to reach the Apple App Store:



How to download the app for Android

- Step 1: Use your Android device to log into Google Play Store
- Step 2: Type 'Desk Connect' in the search column
- Step 3: Select the 'Desk Connect' app
- Step 4: Click 'install' to download the app to your device

You can also scan this QR code to reach the Google Play Store:



To connect the app and the desk, set the DPI in pairing mode by pressing the connect button on the bottom of the DPI for two seconds (Fig. 45).

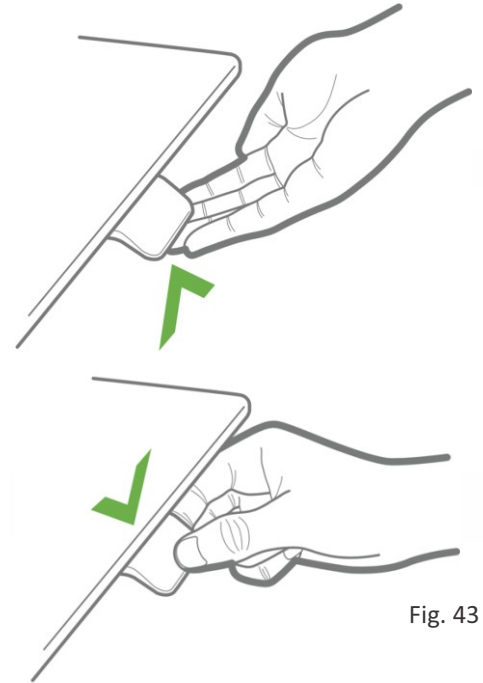

Fig. 43



Fig. 44

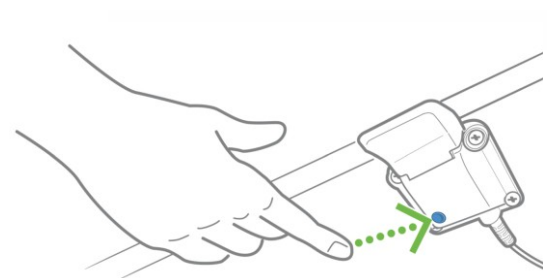

Fig. 45

Adjusting the desk height (Cont.)

YAKETY YAK 200 Series Desks and 300 Series Counter height adjustment

YAKETY YAK 200 Series Desks and 300 Series Counters come fitted with a LINAK DPF1C height-adjust panel (Fig. 46) equipped with the following features:

- Up/down drive
- 3 memory positions
- White LED height calibration display

Operation

The desk panel is operated by pressing and holding the up or down buttons to lift or lower the desk worktop. Release the button when you have reached your requested position (Fig. 47).

For detailed product information download the [LINAK User Manual](#)



Fig. 46

Programming the height pre-sets

How to store a position

1. Drive the worktop to the desired height.
2. Press the 'S' button (Fig. 47), (an 'S' appears in the display) and then one of the three memory buttons (Fig. 48). The memory button number, 1, 2 or 3 appears in the display. Your position has now been stored.
3. To clear and re-set the memory button, simply choose a new height and re-save.
4. To drive the worktop to a stored position, simply press and hold the desired memory button.



Fig. 47



Fig. 48

Lifting columns

Your YAKETY YAK Pods, Desks and Counters are fitted with either the LINAK DL2 lifting column (Fig. 49), or twin DL6 columns (Fig. 50). The columns operate in conjunction with a LINAK CBD6 controller for their height-adjust functionality.

Fitted with anti-collision technology

For staff and customer safety, both DL2 and DL6 height-adjust systems incorporate anti-collision technology. This causes the moving worktop to stop and back off, should an obstruction get in the path of travel.

Re-setting the column controller

Very occasionally the controller (mounted under the desktop to the center back) may become 'confused' and the desk will not adjust upwards. This can be caused by the worktop hitting an obstruction when in motion. In such circumstances, the DOWN button will still function.

To re-set:

1. Press the DOWN button on the desk panel until the worktop reaches its lowest level, and continue to hold down for ten seconds while the controller resets itself. (You may see the desktop jiggle slightly as the lifting columns re-set.)

2. Now raise the worktop to the full height available and lower again to the bottom of the stroke to establish the range parameters.

Your system is now reset.

If for any reason the mechanism does not lower or re-set, please contact us (see contacts at the bottom of this page).

Looking after the height adjust equipment

The mechanisms will remain in good repair for many years with regular use. Not using the mechanism regularly may result in eventual damage. A good idea is to ensure the mechanisms are used sometime in every workday.

Lifting column system overuse

Pods and 400 Series Desks (with DL2 lifting column): The height-adjust system can be used continuously for a maximum of one minute at full 150kg load, after which it should not be used for a minimum of 19 minutes.

200 Series d and 300 Series Counters (with dual DL6 lifting columns): The height-adjust system can be used continuously for a maximum of two minutes at full 240kg load, after which it should not be used for a minimum of 18 minutes. More prolonged use may result in overheating and a dramatic reduction in the life of the system.



Fig. 49



Fig. 50

Lifting columns (Cont.)

Troubleshooting should the lifting mechanism not respond

1. Ensure the control box power lead is firmly plugged in at both ends. You will find the black control box fixed to the worktop underside, center back. The desk panel display should be on.
2. Ensure the leads from the control box out to the lifting columns are firmly plugged in at both ends.
3. Ensure no object is in the way of worktop travel. If the desktop has impacted a stationary object, it will likely require re-setting (see section above).

Monitor arm option

[CLICK to view ATDEC Monitor Arms](#)

For desks utilising one of our ATDEC Monitor Arm options (Fig. 51), the arms ship boxed and require assembly and mounting by the customer.

A factory drilled mounting hole is provided on the desktop in the optimum position to suit the particular monitor arm.

Each arm comes with full installation instructions in the box.



Fig. 51

D2D USB Charger option

Our handy D2D USB Charger, which provides one USB-A and two USB-C high speed sockets right at your finger tips (Fig. 52).

Our D2D USB Charger comes factory fitted ready to use and draws its power from the height adjust system controller, so you don't need to plug it in. Once the height-adjust system is plugged in and live the D2D device will function.

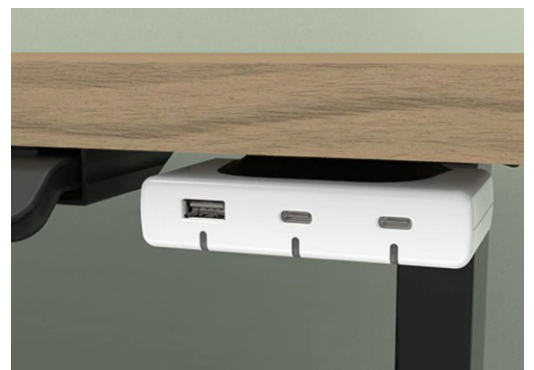

Fig. 52

Lollipop Illuminated Sign Pole option

[CLICK to view LOLLIPOP Illuminated Sign Pole](#)

The Lollipop Illuminated Sign Pole (Fig. 53) is a great way to catch attention and to guide enquirers to your desk for assistance. The unit is pre-wired to the desk and ships flat to minimise shipping charges. The sign pole requires simple mounting by the customer.

WARNING Lollipop is delicate - fabricated in acrylic and fitted with a low voltage LED lighting system; it needs to be handled carefully.

To commission

Lollipop comes fully assembled and pre-wired. Sufficient play in the cabling is allowed so the pole can be layed flat on the desktop for shipping. From the pole the cable reticulates down the mounting hole in the desktop.

1. After unwrapping, raise the pole to a vertical position over the hole and feed the surplus cable back up into the pole. The round sign head should be aligned to the desktop centreline. (Fig. 54).

2. In the bottom of the pole you will see two grooves, one either side (Fig. 30). Also, under the desktop you will see a white mounting bracket in line with the mounting hole in the desktop. The grooves in the pole are designed to locate over two corresponding lugs in the mounting bracket. Carefully, lower the pole into the mounting hole until it is firmly located (Fig. 55, Fig 56).

The Lollipop Illuminated Sign Pole is now ready to use. The light can be turned on and off using the black button on the desktop (Fig. 53).

To apply graphics to the sign pole head

If you have not ordered the sign pole display panels to have graphics applied at the factory, you can arrange with your own signage contractor to do this on-site. We advise the pole be lifted clear of the mounting hole and laid flat on a soft cloth on the desktop in order to apply the graphics.

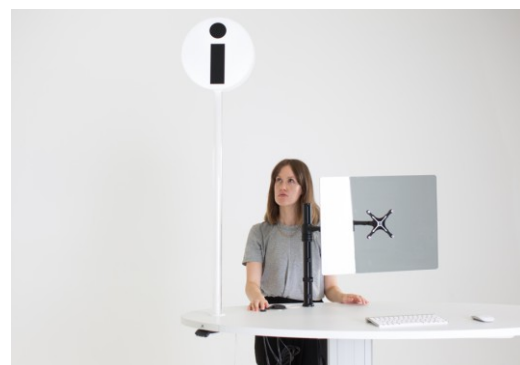

Fig. 53

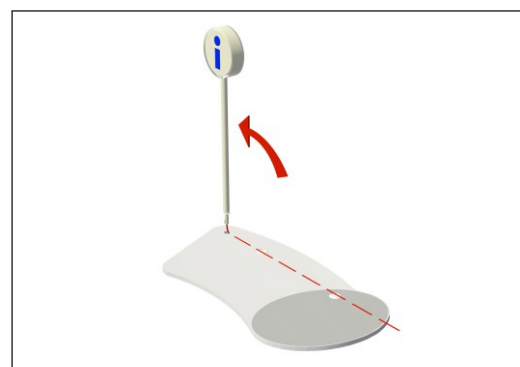

Fig. 54

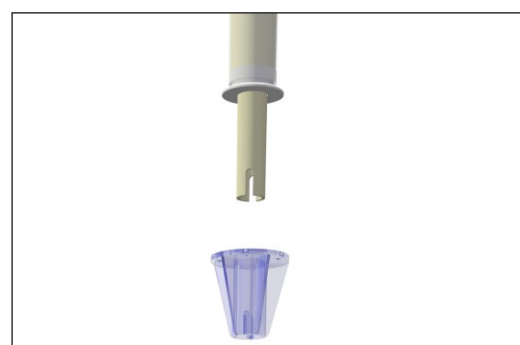

Fig. 55

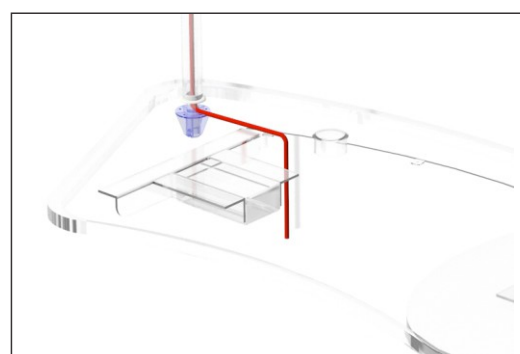

Fig. 56

Warnings

YAKETY YAK pods, desks and counters contain moving and electrical parts, and as such are potentially hazardous if handled or operated incorrectly.

Operating the height-adjustment mechanism

1. Always check that there are no obstructions under, on top or alongside the pod that could restrict safe operation of the adjustment mechanism.
2. Do not store anything in the barrel that could become caught or tangled in the adjustable mechanism or cabling.
3. Do not store anything under the pod that would encroach into the operating height range of the mechanism.
4. Always keep clear of moving parts when operating the mechanism.
5. Be aware of other people nearby when operating the mechanism. Particularly watch for children.
6. Ensure there is sufficient slack in any cables to equipment on the worktop to comfortably allow for the full range of movement of the worktop.

Moving

1. On pods, always remove upper and lower barrels, disconnect all services to the pod and lift the leads clear before moving the pod.
2. On desks and counters, always disconnect all services and lift leads clear before moving.
3. Before moving, first check to ensure your route is clear. Be particularly careful on ramps.
4. To move, position a person at each end. Use a third person at the front to help slow and guide the descent on ramps.
5. If moving a pod on its retracting castors, the pod may tend to tilt forward so ensure the front two castors are fully wound down (to the stop nut) and that the leading person maintains upward pressure on the worktop nose while moving.
6. If moving on a dolly, ensure the unit is balanced and stable. DO NOT attempt to move alone.
7. If moving a desk with castors, ensure all castor brakes are applied one in position.

Handling pod barrels

1. The upper barrel shells each weigh 5.2kg and the lower barrel shells each weigh 5.8kg. When handling the barrel shells, be careful to use safe lifting techniques.
2. Once fitted it is important that both upper barrel shells are ALWAYS left locked. The barrel locks with a quarter turn clockwise. Locking prevents a barrel shell being accidentally knocked loose from its hanging brackets.

Soft cable reticulation

1. All leads for desktop equipment must be routed to below the worktop via the cable port (grommet) provided.
2. On pods between the upper barrel and the desktop is a narrow ventilation gap. DO NOT reticulate leads from the desktop into the barrel space via this gap. The leads will prevent the upper barrel from locating and locking onto its hanging brackets, allowing the barrel to drop off.

Floor fixing

1. To ensure stability and safety, counters, cash and book return modules should be fixed to the floor during installation using the brackets and fixings provided.

Disclaimer

We provide this Delivery and Installation Guide in good faith to assist you in preparing for delivery day and to instruct you in the use of our products. In doing so, Yakety Yak Furniture assumes no responsibility or liability for your use of the information provided and gives no guarantees of its completeness, accuracy, usefulness, timeliness or avoidance of expense, damage, injury or harm. Yakety Yak Furniture also retains the right to alter its products at any time without warning.



If you require further information please email: enquiries@yaketyyakfurniture.com
YAKETY YAK Furniture products and trademarks are protected by international intellectual property laws.